







EXPORT CATALOGUE

WHEEL ALIGNERS *& Original Accessories*



EFFECTIVE FROM JANUARY 2024
REL. MARCH 2024

COLOR TABLE

Standard		RAL 3002	Red	→ /16
Optional		RAL 1007	Yellow	→ /40
Optional		RAL 5015	Blue	→ /25
Optional		RAL 9006	Light Grey	→ /36

NEXION SPA reserves the right to change the specifications of its products at any time without prior notice. The company declines all responsibility in the event of claims deriving from the use of non-original accessories or spare parts with consequent forfeiture of the EC declaration of conformity.

PRE-CHECK DRIVE-THROUGH	4
DYNAMIC T-CHECK	4
T-CHECK SYSTEM	5
PROFILE READER FOR T-CHECK	6
COMPULSORY ACCESSORIES FOR T-CHECK SYSTEM	7
OPTIONAL ACCESSORIES T-CHECK	8
TECO T-PROFILE STANDALONE	13
OPTIONAL ACCESSORIES FOR T-PROFILE STANDALONE	14

TRADITIONAL WHEEL ALIGNERS	16
TECO 804 SPECIAL MOBILE	16
TECO 804 SPECIAL SMART	17
OPTIONAL ACCESSORIES FOR TECO 804 SPECIAL MOBILE AND 804 SPECIAL SMART	18
TECO 804 SPECIAL	20
TECO 814 SPECIAL	21
TECO 820	22

3D CAMERA WHEEL ALIGNERS	22
TECO 920	23
TECO 920 DRIVE THROUGH	24
COMPULSORY ACCESSORIES FOR TECO 920 DRIVE THROUGH	25
OPTIONAL ACCESSORIES FOR TECO 820 - TECO 920 - TECO 920 DRIVE THROUGH	26
TECO 990	41
OPTIONAL ACCESSORIES	42

DYNAMIC T-CHECK



Analysis of the forces exerted from the wheels and prediction of the tire wear



Dynamic pass-through precheck for quick verification of vehicle geometry for cars and light trucks



Code	Electrical Supply	Description
0-35101101/16	100-240Vac / 1 Ph / 50-60Hz	Dynamic T-Check Full Pack: includes central unit with cabinet, PC, keyboard, mouse, processing system, measuring platforms for recessed installation and traffic light.
0-35101201/16	100-240Vac / 1 Ph / 50-60Hz	Dynamic T-Check KIT: includes the processing system, measurement platforms for recessed installation and traffic light
8-35600003		Customization kit to be ordered with Dynamic T-Check: includes software, user manuals, customization items (compulsory)

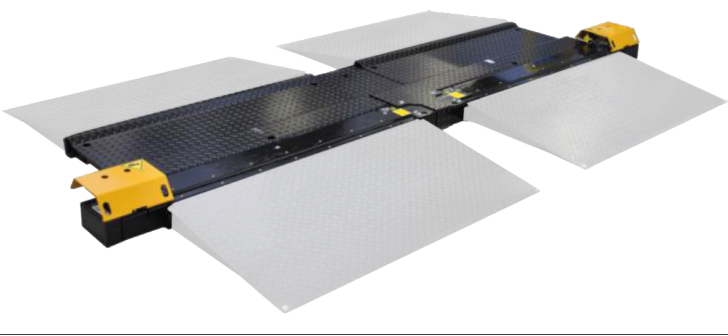
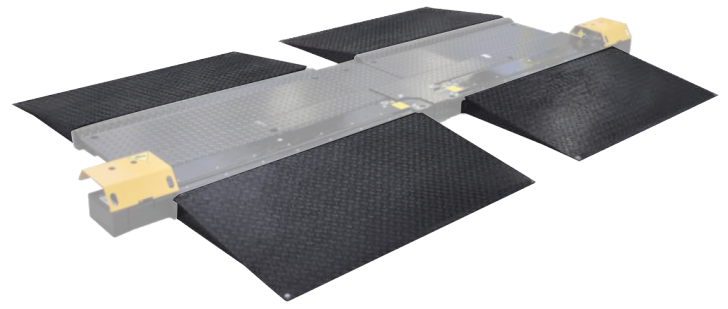
T-CHECK SYSTEM

Full Top Complete Version


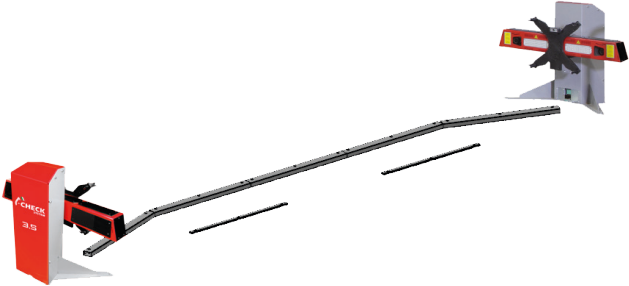


Code	Description	
0-35600101/16	T-Check System 3,5 FAST Including 2x measuring units for front axle, 1x main control unit with PC, keyboard, and trackball, 27" monitor.	
0-35600201/16	T-Check System 3,5 FULL Including 2x measuring units for front and rear axles, 1x main control unit with PC, keyboard and trackball.	
0-35600401/16	T-Check System 3,5 FAST TOP Including 2x measuring units for front axle, 1x main control unit with PC, keyboard and trackball, 27" monitor, Bull Bar kit, printer unit, Smart Remote kit, RIK, Drive on Assistance, Flat ramps 3,5.	
0-35600301/16	T-Check System 3,5 FULL TOP Including 2x measuring units for front and rear axles, 1x main control unit with PC, keyboard and trackball, 27" monitor, Bull Bar kit, printer unit, Smart Remote kit, RIK, Drive on Assistance, Flat ramps 3,5.	




PROFILE READER FOR T-CHECK

Image	Description	Code	
	<p>T-PROFILE: integrated version to T-CHECK SYSTEM, designed for in-pit installation; the ramps for the on-floor installation are NOT included.</p>	8-3560001	
	<p>Ramps for T-PROFILE: ramps kit for on-floor installation.</p>	8-35100021	

COMPULSORY ACCESSORIES FOR T-CHECK SYSTEM

Image	Description	Code	
	<p>MNT27-M 27" LCD Multimedia Monitor (for FAST and FULL versions).</p>	<p>8-34100016</p>	
	<p>Flat ramps 3,5 (for FAST and FULL versions).</p>	<p>8-35100018</p>	

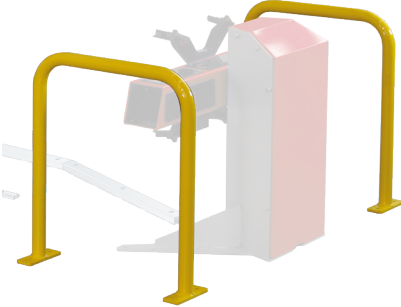

OPTIONAL ACCESSORIES T-CHECK

Image	Description	Code	
	LAUNCHER: software management.	8-35100026	
	LAUNCHER with Auto QR: software management + QR code generation system.	8-35100029	
	update to auto qr: for updating launcher precheck cod. 8-35100026 to launcher auto qr cod. 8-35100029.	8-35100067	






Flow chart for Pre-Check management

Model	Launcher	Auto QR	WEBCAM front/rear	Printer for QR Code
Launcher (cod. 8-35100026)	Standard	Not Included	Standard	Not Included
Launcher + Auto QR (cod. 8-35100029)	Standard	Standard	Standard	Standard
+ Auto QR (cod. 8-35100067)	Not Included	Standard	Not Included	Standard







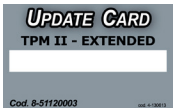
OPTIONAL ACCESSORIES T-CHECK

OPTIONAL ACCESSORIES T-CHECK				DYNAMIC T-CHECK	T-CHECK SYSTEM
Image	Description	Code			
 x18	Fixing kit for runways, standard floors (18 pcs).	8-35100009	-	0	
 x18	Fixing kit for runways, in case of compact concrete or underfloor heating (18 pcs).	8-35100010	-	0	
	EXTERNAL USB-HARD DRIVE 1TB: accessory for T-CHECK for locally store the LAUNCHER results.	8-35100068	-	0	
	Annual T-Check databank update kit.	8-35100069	-	0	
	Pre-check databank updating kit - DYNAMIC T-CHECK	8-35100093	0	-	
	T-Check U.S.A. databank enable kit. Activation to be renewed every year.	8-35100071	-	0	
	BULL BAR kit. Bar of protection. For T-CHECK SYSTEM 3.5 F.A.S.T. and T-CHECK SYSTEM 3.5 FULL.	8-35100003	-	0	
	Kit 122: for F.A.S.T. version to enable rear axle scan. For T-Check System 3.5 F.A.S.T. and T-Check System 3.5 FULL.	8-35100014	-	0	






OPTIONAL ACCESSORIES T-CHECK

Image	Description	Code		DYNAMIC T-CHECK	T-CHECK SYSTEM
	MNT 27 - 27" LCD Monitor	8-34120000		o	-
	Universal LCD monitor holder	8-61200143		o	-
	Smart Remote kit Including 1 dedicated APP, 1 tablet, 1 rubber protection cover. For T-Check System 3.5 F.A.S.T. and T-Check System 3.5 FULL.	8-35100016		-	o
	NEXREMOTE The tablet is used as a remote control unit of the graphic user interface or as an additional portable monitor. It can also be used to show in real time to the customer the current vehicle status.	8-31100001		o	-
	RIK Rim Imaging Kit (1 software update). For T-Check System 3.5 F.A.S.T. and T-Check System 3.5 FULL.	8-35100017		-	o

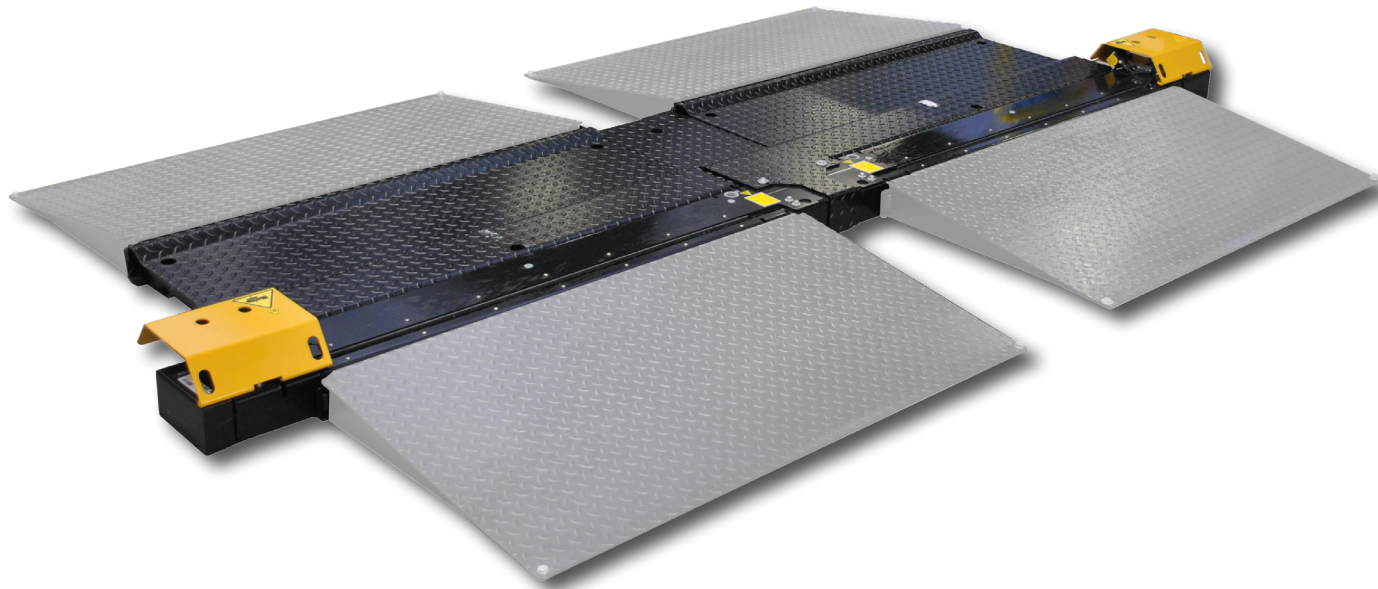
OPTIONAL ACCESSORIES T-CHECK

Image	Description	Code		DYNAMIC T-CHECK	T-CHECK SYSTEM
	Inkjet coloured printer	8-61200237		0	-
	USB colour inkjet printer For T-Check System 3.5 F.A.S.T. and T-Check System 3.5 FULL. Available only for shipment from Italy	8-21120005		-	0
	Professional calibration kit Including: offset bar, calibration target, calibration laser, magnetizing digital level, drawn alloy bars.	8-35100005		-	0
	Wireless remote control kit (with 2.4 GHz industrial radio)	8-35100086		0	-
	TPM-02 Device for checking operation of TPMS sensors, compatible for LAUNCHER or LAUNCHER software package with AUTO QR.	6015001300		-	0
	Subscription 12M TPM-02 standard.	8-51100029		-	0
	Subscription 12M TPM-02 extended.	8-51120003		-	0

OPTIONAL ACCESSORIES T-CHECK


Image	Description	Code		DYANIMC T-CHECK	T-CHECK SYSTEM
	<p>Camera headlights tester to check the vehicle front headlights, suitable for T-CHECK equipped with LAUNCHER or LAUNCHER with AUTO QR</p>	8-35100030		-	o
	<p>QR-CODE SCANNER KIT: wireless QR_CODE scanner.</p>	8-35100065		-	o
	<p>Steering wheel level to help in the steer position calibration procedure.</p>	8-33100050		-	o
	<p>Ramp kit for floor installation</p>	8-35100084		o	-
	<p>Booking service enabling kit</p>	8-35100088		o	-

teco T-PROFILE STANDALONE





Code	Description	
0-35100601/39	T-Profile Standalone FULL PACK Stand-alone profilometer with integrated laser - recessed installation - Profilometer, cabinet, PC, mouse trackball, printer unit, electrical system interface included.	
0-35100701	T-Profile Standalone KIT - Stand-alone profilometer with integrated laser - recessed installation - Profilometer, electrical system interface included.	
8-35600002	Compulsory customization kit for T-PROFILE Standalone.	

OPTIONAL ACCESSORIES FOR T-PROFILE STANDALONE

Image	Description	Code	
<p>IMMAGINE NON DISPONIBILE</p>	<p>Management Software Package for T-PROFILE Standalone</p>	<p>8-35100061</p>	
	<p>T-PROFILE RAMPS: ramps kit for on-floor installation</p>	<p>8-35100021</p>	
	<p>27" Basic Monitor LCD</p>	<p>8-34120000</p>	
	<p>LCD monitor holder</p>	<p>8-61200143</p>	

OPTIONAL ACCESSORIES FOR T-PROFILE STANDALONE

Image	Description	Code	
	<p>Inkjet coloured printer</p>	<p>8-61200237</p>	
	<p>Mouse kit (only for T-PROFILE STANDALONE KIT).</p>	<p>8-33100078</p>	

TECO 804 *Special* MOBILE



STANDARD ACCESSORIES

BST



BF



Code	Electrical Supply	Description	
0-33603601/16	100/230V - 1Ph - 50/60Hz	TECO 804 Special Mobile Portable electronic wheel aligner with professional alignment software for cars and vans, 4 measuring heads with 8 sensors and «wireless» data transmission system. Supplied in hard case.	

TECO 804 *Special* SMART



STANDARD ACCESSORIES

BST





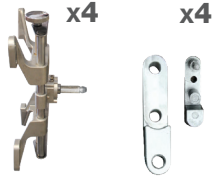


BF




Clamps NOT included

Code	Electrical Supply	Description
0-331140101/39	100/240Vac - 1Ph - 50/60Hz	TECO 804 SPECIAL SMART Wheel aligner including 4 wireless sensors and "docking station "(equipped with charging stands, battery charger and brackets holder), steering wheel lock and depressor. Floor or wall fixing.
8-33100183		Compulsory customized kit for TECO SPECIAL SMART including alignment software, user manuals, customizing items

OPTIONAL ACCESSORIES FOR TECO 804 SPECIAL MOBILE AND 804 SPECIAL SMART

Image	Description	Code		TECO 804 SPECIAL MOBILE	TECO 804 SPECIAL SMART
	PC WINDOWS 10	8-33100164		0	0
	Rugged laptop PC with Windows 10	8-33100170		0	0
	4x 4-points 11"-21" wheel clamps for cars, with 26" extenders included.	8-34100022		-	0
	4x 4-points 11"-21" wheel clamps for cars.	8-34100020		-	0
	Kit of extenders to 26" for clamps code 8-34100020.	8-34100021		-	0

OPTIONAL ACCESSORIES FOR TECO 804 SPECIAL MOBILE AND 804 SPECIAL SMART

Image	Description	Code		TECO 804 SPECIAL MOBILE	TECO 804 SPECIAL SMART
	<p>Printer cabinet</p>	<p>8-34900036/16</p>		-	o

TECO 804 Special

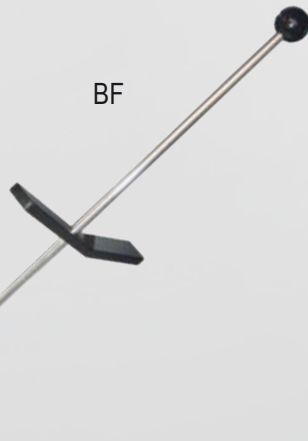


STANDARD ACCESSORIES

BST



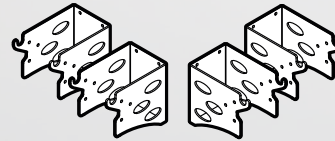
BF



MNT 19



K4ST



Code	Electrical Supply	Description
0-33603701/16	100/230V - 1Ph - 50/60Hz	TECO 804 Special Electronic wheel aligner with professional alignment software for cars and vans, 4 measuring heads with 8 sensors and «wireless» data transmission system. Primary data bank composed of more than 20.000 vehicles;

TECO 814 Special



STANDARD ACCESSORIES

BST



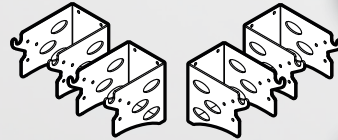
BF



MNT 19



K4ST



Code	Electrical Supply	Description
0-33603801/16	100/230V - 1Ph - 50/60Hz	TECO 814 Special Electronic wheel aligner with professional alignment software for cars and vans, 4 measuring heads with 8 sensors and «wireless» data transmission system and primary data bank composed of more than 20.000 vehicles. Available in TRUCK version complete with truck, trailer and bus alignment functions.

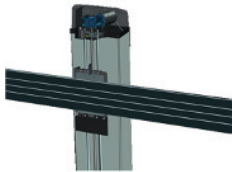
teco820



STANDARD ACCESSORIES



DELIVERY AVAILABLE FROM CHINA ONLY

Code	Electrical Supply	Description	
0-33603901/16	110-230V - 1Ph - 50/60Hz	TECO 820 FULL PACK: with measuring beam, long column, PC, wireless keyboard, wireless mouse, 4 target and 4 clamps 10"-21", 4 adaptor kit for up to 26", steering wheel lock, brake depressor. Monitor LCD, printer and turntables not included. DELIVERY AVAILABLE FROM CHINA ONLY	
8-34900060		CM - Camera Mover with wormgear 115-230V/1PH/50-60Hz DELIVERY AVAILABLE FROM CHINA ONLY	

TECO 920



STANDARD ACCESSORIES



*For Full Pack versions only

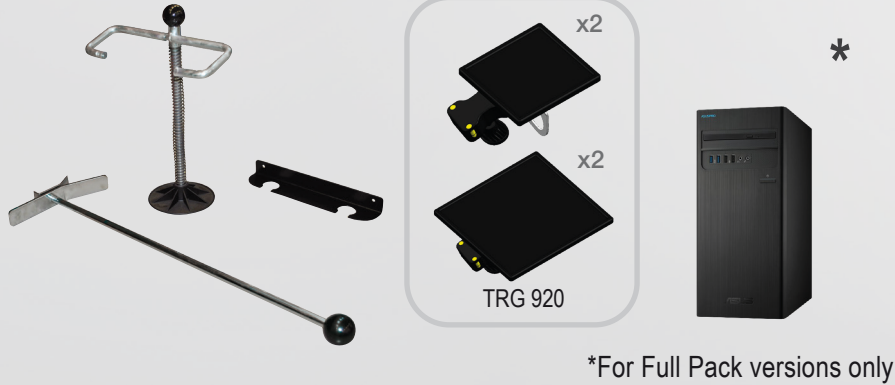


Code	Electrical Supply	Description
0-34102201/36	115/230V - 1Ph - 50/60Hz	TECO 920 FULL PACK: 2 camera professional wheel aligner for cars and vans. Two 5-Megapixel digital camera for machine vision. New light targets with anti-reflective filter, suitable for any wheel clamp. Provided with measuring beam, column, PC, keyboard, mouse, 4 hi-resolution small targets, steering wheel lock, brake depressor. LCD Display, printer, wheel clamps and turntables not included
0-34102301/36	115/230V - 1Ph - 50/60Hz	TECO 920 NO-PC 2 camera professional wheel aligner for cars and vans. Two 5-Megapixel digital camera for machine vision. New light targets with anti-reflective filter, suitable for any wheel clamp. Provided with measuring beam, column, 4 hi-resolution small targets, steering wheel lock, brake depressor. LCD Display, wheel clamps, PC, printer, keyboard, mouse and turntables not included.
8-34900069/16		Customization kit: alignment software, user manuals, customization item (compulsory)

TECO 920 DRIVE THROUGH

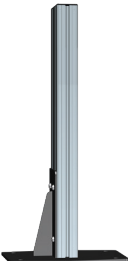
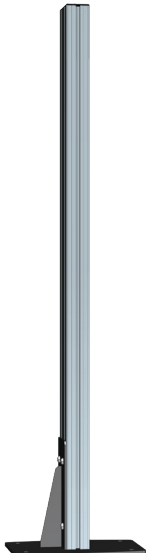


STANDARD ACCESSORIES

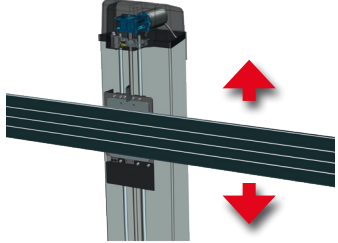

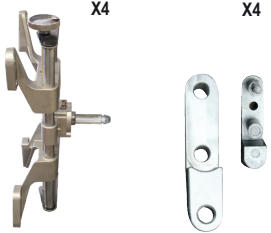




Code	Electrical Supply	Description	
0-34102401/16	115/230V - 1Ph - 50/60Hz	TECO 920 DRIVE THROUGH FULL PACK: Wheel aligner and precheck with two Hi-Q digital camera for machine vision, suitable for any wheel clamp. Provided with camera measuring units, wheeled cabinet, PC, keyboard, mouse, 4 hi-resolution light targets with anti-reflective filter, steering wheel lock, brake depressor. LCD Display, printer, wheel clamps, turntables and side posts not included.	
0-34102501/16	115/230V - 1Ph - 50/60Hz	TECO 920 DRIVE THROUGH NO-PC: Wheel aligner and precheck with two Hi-Q digital camera for machine vision, suitable for any wheel clamp. Provided with camera measuring units, wheeled cabinet, 4 hi-resolution light targets with anti-reflective filter, steering wheel lock, brake depressor. PC, keyboard, mouse, LCD display, printer, wheel clamps, turntables and side posts not included.	
8-34900086		Customization kit to be ordered with 920 DRIVE THROUGH: alignment software, user manuals, customization items (compulsory)	






COMPULSORY ACCESSORIES FOR TECO 920 DRIVE THROUGH

Image	Description	Code	
	<p>KIT LOW COLUMNS (1.000mm): for installation in pit or for precheck in acceptance. COMPULSORY (as an alternative to P/N 8-34900081)</p>	8-34900080	
	<p>KIT HIGH COLUMNS (2600 mm): for installation with hoist. Measurement and adjustment operations at fixed height. COMPULSORY (as an alternative to P/N 8-34900080)</p>	8-34900081	

OPTIONAL ACCESSORIES FOR TECO 820 - TECO 920 - TECO 920 DRIVE THROUGH






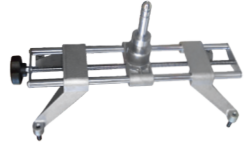
Image	Description	Code		TECO 820	TECO 920	TECO 920 D. T.
	Camera Mover with wormgear 115/230V - 1PH - 50/60Hz. (Delivery available both from Italy and China)	8-34900064		-	o	-
	Autotracking enabling kit for camera mover with wormgear (Delivery available both from Italy and China)	8-34900071		-	o	-
	4-points 11"-21" wheel clamps for cars, with 26" extenders included (4 pcs) (Delivery available both from Italy and China)	8-34100022		-	o	o
	4-points 11"-21" wheel clamps for cars (4 pcs) (Delivery available both from Italy and China)	8-34100020		-	o	o
	Kit of extenders to 26" for clamps code 8-34100020 (Delivery available both from Italy and China)	8-34100021		-	o	o

OPTIONAL ACCESSORIES FOR TECO 820 - TECO 920 - TECO 920 DRIVE THROUGH


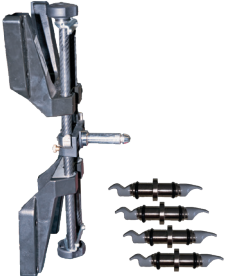





Image	Description	Code		TECO 820	TECO 920	TECO 920 D. T.
	Turntable and transition blocks. Dimensions: 485 x 435 x 50 mm. Load 1000 kg (Delivery available both from Italy and China)	8-34900019		0	0	0
 x2	ROC push-mode kit - for turntables 8-34900019 (Delivery available both from Italy and China)	8-34100052		0	0	0
	PRINTER CABINET Cabinet for printer unit. (Delivery available both from Italy and China)	8-34900036/16		0	0	0
	Drive On Assist (Delivery available both from Italy and China)	8-34900021		-	0	-
	CU Calibration Unit (Delivery available both from Italy and China)	8-34900011		0	0	0

NEW!






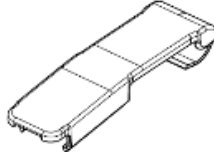
OPTIONAL ACCESSORIES FOR TECO 820 - TECO 920 - TECO 920 DRIVE THROUGH

Image	Description	Code		TECO 820	TECO 920	TECO 920 D. T.
	Standard rim kit for one clamp (4 pins) (Delivery available both from Italy and China)	8-34900041		o	o	o
	Trolley 2.0: trolley for wheel clamps and targets	8-34900074/16		o	o	o
	A4 Inkjet printer Not available for shipment from Italy	8-34900079		o	o	o
	AS 4-points clamp 10"-21" with fixed central pin for cars and vans (1 pcs).	8-33100130		-	o	o
	Wheel bracket 10" to 21" for cars resin coated/double-profile claws	8-33100177		-	o	o
	AS-2 4-points clamps 12"-21" with fixed central pin for cars and vans (2 pcs). Available extensions PC AS-2.	8-11600024		-	o	o



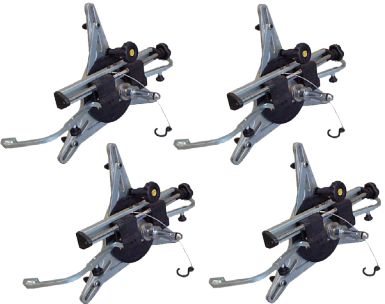


OPTIONAL ACCESSORIES FOR TECO 820 - TECO 920 - TECO 920 DRIVE THROUGH

Image	Description	Code		TECO 820	TECO 920	TECO 920 D. T.
	AS-26 Carbon bracket 10" to 26" for cars (1 pcs).	8-33100159		-	0	0
	Extra-light 4-points clamp 10" to 26" with carbon inserts and resin coated/double-profile claws	8-33100166		-	0	0
	Wheel hook kit for 4-points clamps (kit for 4 clamps)	8-33100184		-	0	0
	Kit of 4 plastic pins type 1	8-33100185		-	0	0
	Kit of 4 plastic pins type 2	8-33100186		-	0	0
	Kit of 4 plastic pins type 3	8-33100187		-	0	0
	KIT4 AS26 Extension kit for AS-26 to increase clamping capacity of 4" (4 pcs – 4 pcs/clamp). Truck capable.	8-33100100		-	0	0





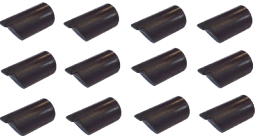
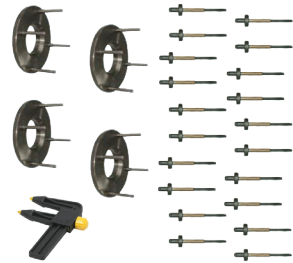
OPTIONAL ACCESSORIES FOR TECO 820 - TECO 920 - TECO 920 DRIVE THROUGH

Image	Description	Code		TECO 820	TECO 920	TECO 920 D. T.
	AM-2 Quick clamp 9" to 21" for cars (1 pcs).	8-33100025		-	0	0
	ClampOnTyre: Quick, self-centring, ergonomic. Fixing to the wheel, without contact with the rim. The supplied jaws allow gripping on wheel diameters from 19" to 32". Wheel arch protection included. The code includes one clamp. <small>REMARK: TO USE THE CLAMPONTYRE WITH TECO 920 ALIGNER IT IS MANDATORY TO ORDER KIT 8-34100048</small>	8-33100189		-	0	0
	Set of extensions for vans: set for use with vans. Kit for one clamp.	8-33100191		-	0	0
	Set of XL extensions: for wheel diameter from 32" to 39". Kit for one clamp.	8-33100190		-	0	0
 x4	Fall protection steel cable kit for 4 clamps: includes 4 steel cables and mounting components. Compatible with ClampOnTyre.	8-33100196		-	0	0
 x15	Wheel Rim Guard Kit: Plastic protection for very protruding rims. Compatible with ClampOnTyre.	8-33100197		-	0	0









OPTIONAL ACCESSORIES FOR TECO 820 - TECO 920 - TECO 920 DRIVE THROUGH

Image	Description	Code			
			TECO 820	TECO 920	TECO 920 D. T.
	Clamp holder multi-purpose trolley and additional jaws.	8-33100193	-	0	0
	Clamp holder set for wall mounting with support for additional jaws.	8-33100192	-	0	0
	Set of four 3-point automatic quick clamps from 10" to 21" for ALU rims and well centered rims, "Run Out" compensation is not required	803269218	-	0	0
	Set of 12 claws for Iveco Daily steel rims, suitable for code 803268218 and code 8-33100025	803289414	-	0	0
	Set of 12 extensions to 23" for 3-point quick clamps, suitable for code 803268218 and code 8-33100025	8-33200003	-	0	0

OPTIONAL ACCESSORIES FOR TECO 820 - TECO 920 - TECO 920 DRIVE THROUGH

Image	Description	Code		TECO 820	TECO 920	TECO 920 D. T.
	Set of 12 short claws, suitable for code 803268218 and code 8-33100025	803284944		-	o	o
	Set of 12 long claws (57 mm), suitable for code 803268218 and code 8-33100025	803284945		-	o	o
	Set of 12 shaped claws, suitable for code 803268218 and code 8-33100025	803284946		-	o	o
	Set of 12 extensions, suitable for code 803268218 and code 8-33100025	803284947		-	o	o
	Set of 12 claws for outstanding profile rims, suitable for code 803268218 and code 8-33100025	8-33200004		-	o	o
	Complete set of Mercedes and BMW adapters (25 pcs), suitable for code 803268218 and code 8-33100025	803284942		-	o	o



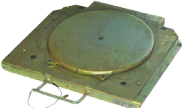
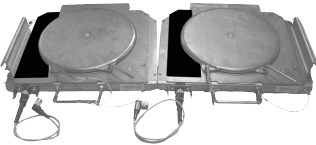
OPTIONAL ACCESSORIES FOR TECO 820 - TECO 920 - TECO 920 DRIVE THROUGH

Image	Description	Code		TECO 820	TECO 920	TECO 920 D. T.
	Complete set of Porsche adapters (4+4 pcs.), suitable for code 803268218 and code 8-33100025	803284943		-	0	0
	CAB Safety cables for measuring heads. To be fixed on clamps (4 pcs).	803261239		-	0	0
	PC AS-2 Extension kit for AS-2 to increase clamping till 26" (4 pcs – 2 pcs/clamps). Truck capable.	8-11600025		-	0	0
	PC AR-2 Set of three 28" extensions for single rapid clamp 8-33100025.	8-33100026		-	0	0
 x4	KIT 1-4 Grippers 43 mm for alloy rims for AS-2 (4 pcs - 4 pcs/clamp).	100023100		-	0	0
 x4	KIT 2-4 Grippers 46 mm for thick edge rims for AS-2 (4 pcs - 4 pcs/clamp).	100023300		-	0	0
 x4	KIT 3-4 Grippers 98 mm for van rims for AS-2 (4 pcs - 4 pcs/clamp).	100022600		-	0	0
 x4	KIT SSC-1 Double grippers for steel and alloy rims (4 pcs - 4 pcs/clamp).	8-33100039		-	0	0


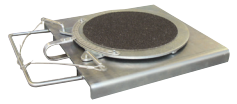
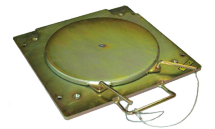

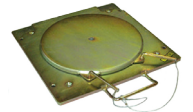
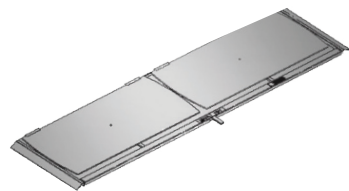

OPTIONAL ACCESSORIES FOR TECO 820 - TECO 920 - TECO 920 DRIVE THROUGH

OPTIONAL ACCESSORIES FOR TECO 820 - TECO 920 - TECO 920 DRIVE THROUGH				TECO 820	TECO 920	TECO 920 D.T.
Image	Description	Code				
 x4	KIT SSC-2 Double grippers for rims with wheel cover and alloy rims (4 pcs - 4 pcs/clamp).	8-33120000		-	0	0
	Kit of 4 resin coated/double-profile claws for wheel clamps code 8-33100159 and 8-33100130. One kit for one clamp.	8-33120002		-	0	0
	Kit of 4 resin coated/double-profile SCC claws for wheel clamps code 8-33100159 and 8-33100130. One kit for one clamp.	8-33120003		-	0	0
	Kit of 4 resin coated double-profile claws for wheel clamps. One kit for one clamp	8-33120001		0	0	0
 x4	Kit 5 Kit of short grippers for AM-2 (12 pcs - 3 pcs/clamp).	803284944		-	0	0
 x4	Kit 6 Kit of long grippers for AM-2 (12 pcs -57 mm- 3 pcs/clamp).	803284945		-	0	0
 x4	Kit 7 Kit of short shaped grippers for AM-2 (12 pcs - 3 pcs/clamp).	803284946		-	0	0
 x4	Kit 9 Kit of short shaped grippers for AM-2 (12 pcs - 3 pcs/clamp).	803284947		-	0	0






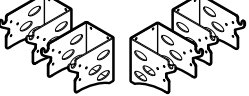

OPTIONAL ACCESSORIES FOR TECO 820 - TECO 920 - TECO 920 DRIVE THROUGH

Image	Description	Code	TECO 820	TECO 920	TECO 920 D. T.
	Pair of car mechanical turntables with ROC push-mode kit (without wheel stop) Dimensions 400x450x50 mm - Ø 320 mm - range ± 40 mm. Load 1.000 kg.	8-33100102	o	o	o
	Pair of wheel stops for platforms code 8-33100102.	8-33100103	o	o	o
	Pair of mechanical turntables Dimensions 375x305x50 mm - Ø 310 mm - Range ± 35 mm Load 1000 kg.	803268866	o	o	o
	Pair of pads for mechanical turntable 803268866.	8-33100111	o	o	o
	High mechanical turntable for cars (wheel stop included). Dimensions 400x450x53 mm - Ø 320 mm - Range ± 40 mm. Load 1000 kg.	804241069	o	o	o
	Medium profile turntable Dimensions 400x450x36 mm - Ø 320 mm - Range ± 40 mm. Load 1000 kg.	803227745	o	o	o
	ROC push-mode kit Iron turntable to be combined with 804241069, 03227745 and 8-33100102. MANDATORY FOR PRODUCTS USING THE "ROC SMART" FUNCTION.	803259570	o	o	o





OPTIONAL ACCESSORIES FOR TECO 820 - TECO 920 - TECO 920 DRIVE THROUGH

Image	Description	Code		TECO 820	TECO 920	TECO 920 D. T.
	LPT Turntable spacers for «push-mode ROC» (2 pcs).	8-11600146		o	o	o
	CPRM-4 Pair of mechanical turntables for cars and vans. Dimensions L=350mm / H=40mm. Load 2,0T.	8-21600170		o	o	o
	CPRA-2 Pair of truck turntable. Dimensions 450x450x24 mm - Ø 365 mm - Range ± 45 mm. Load 3000 kg.	100024200		-	o	o
	CPP-3 Pair of short slip plate. Dimensions 835x370x37 mm. Load 1000 kg.	8-11600184		-	o	o
	Low profile turntable. Dimensions 400x450x26 mm - Ø 320 mm - Range ± 40 mm. Load 1000 kg.	803229274		o	o	o
	Long slip plate - 1 PIECE Dimensions 1732x535x25 mm Load 1000 kg	803231255		-	o	o
	VAS BAR Specific bar for TOE measurement for VW & AUDI.	803254284		-	o	o






OPTIONAL ACCESSORIES FOR TECO 820 - TECO 920 - TECO 920 DRIVE THROUGH

Image	Description	Code	TECO 820	TECO 920	TECO 920 D. T.
	KIT Porsche adaptors. Use suggested during application of «No-ROC» procedures.	3-02047	-	0	0
	KIT BM Kit BMW & Mercedes for 5 holes rims. Use suggested during application of «No-ROC» procedures.	803284942	-	0	0
	Pressure bar for Mercedes	8-33100049	-	0	0
	3 points clamp for BMW - MERCEDES (1 unit)	8-33100041	-	0	0
	CAR Smart trolley for clamp & target holders (1 unit).	8-31600011/16	0	-	-
	K4WS 4-point clamp support brackets for on-wall installation (4 pcs).	8-31600017	0	-	0
	DOC camera system for easy vehicle positioning in the working bay.	8-31600014	0	-	-







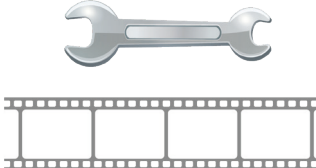
OPTIONAL ACCESSORIES FOR TECO 820 - TECO 920 - TECO 920 DRIVE THROUGH

Image	Description	Code		TECO 820	TECO 920	TECO 920 D. T.
	MNT 27-M 27" LCD Multimedia Monitor.	8-34100016		o	o	o
	MNT 27 27" LCD Monitor.	8-34120000		o	o	o
	MNT 32 32" LCD Monitor.	8-31600016		-	o	-
	MNT 22 22" LCD Widescreen Monitor.	8-21100234		o	o	o

OPTIONAL ACCESSORIES FOR TECO 820 - TECO 920 - TECO 920 DRIVE THROUGH

Image	Description	Code		TECO 820	TECO 920	TECO 920 D. T.
	NEXREMOTE The tablet is used as a remote control unit of the graphic user interface or as an additional portable monitor. It can also be used to show in real time to the customer the current vehicle status.	8-31100001		o	o	o
	Wireless remote control kit (with 2.4 GHz industrial radio).	8-35100060		o	o	o
	Inkjet coloured printer Available only for shipment from Italy	8-21120005		o	o	o
	Steering wheel level to help in the steer position calibration procedure.	8-33100050		o	o	o
	Portable induction heater.	8-35100059		o	o	o

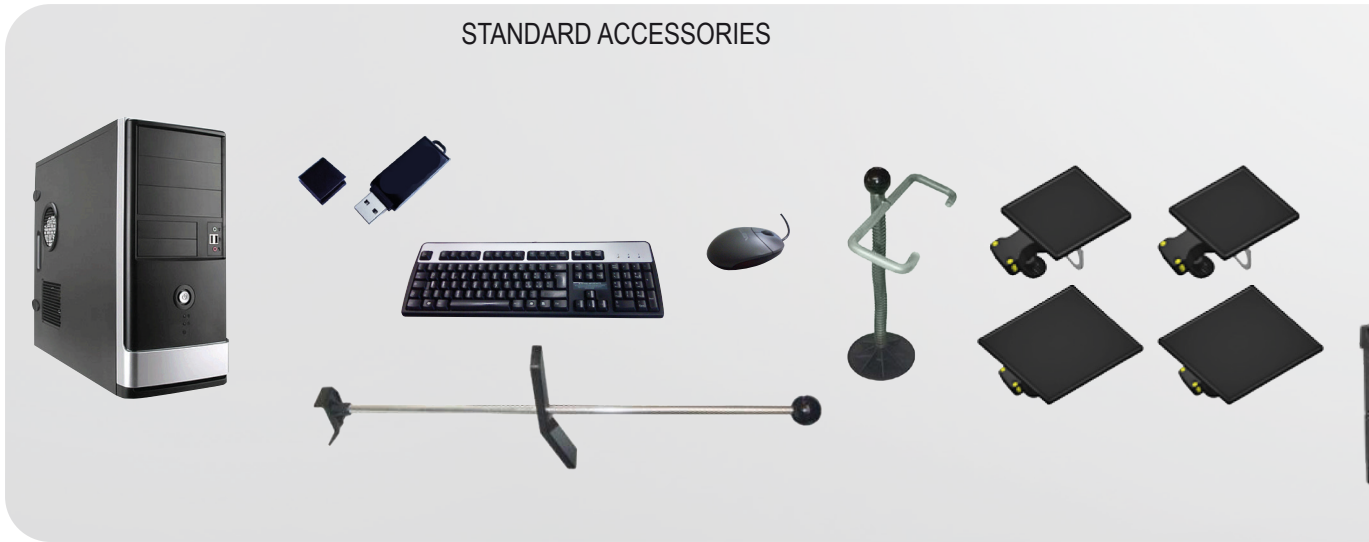
OPTIONAL ACCESSORIES FOR TECO 820 - TECO 920 - TECO 920 DRIVE THROUGH

Image	Description	Code		TECO 820	TECO 920	TECO 920 D. T.
	KFT 820 Anchor set for floor fixing (4 pcs).	8-31600019		0	-	-
	DB T820 Data bank update.	8-34900043		0	-	-
SMART ROC	SMART-ROC feature enable MANDATORY FOR THE USE OF CLAMPONTYRE QUICK CLAMPS	8-34100048		-	0	0
	DB USA T820 Specific US data bank. Renewal required each years.	8-34900077		0	-	-
	DB T920 Data bank update	8-34900078		-	0	0
	DB USA T920 specific US data bank. Renewal required each year	8-34900029		-	0	0
	Wheel alignment On-Line databank - 10 credits card	8-33600012		-	0	0
	T920 Animations full update kit	8-34900053		-	0	0

TECO 990




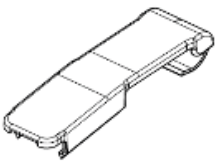


STANDARD ACCESSORIES








Code	Electrical Supply	Description	
0-34103001/49	100/234Vac-1Ph-50/60Hz	TECO 990 FULL PACK: Four Hi-Q digital camera for machine vision, suitable for any wheel clamp. Provided with measuring beam, column, PC, keyboard, mouse, 4 hi-resolution light targets with anti-reflective filter, steering wheel lock, brake depressor. LCD Display, printer, wheel clamps and turntables not included. NEW "ROC SMART" FUNCTION INCLUDED.	
8-34900092/16		Customization kit to be ordered with 990: alignment software, user manuals, customization items (compulsory)	






OPTIONAL ACCESSORIES

Image	Description	Code		TECO 804 SPECIAL MOBILE+SMART	TECO 804 SPECIAL	TECO 814 SPECIAL	TECO 820	TECO 920	TECO 840	TECO 990
	<p>ClampOnTyre: Quick, self-centring, ergonomic. Fixing to the wheel, without contact with the rim. The supplied jaws allow gripping on wheel diameters from 19" to 32". Wheel arch protection included. The code includes one clamp. REMARK: TO USE THE CLAMPONTYRE WITH TECO 920 ALIGNER IT IS MANDATORY TO ORDER KIT 8-34100048</p>	8-33100189		-	-	-	-	0	-	0
	<p>Set of extensions for vans: set for use with vans. Kit for one clamp.</p>	8-33100191		-	-	-	-	0	-	0
	<p>Set of XL extensions: for wheel diameter from 32" to 39". Kit for one clamp.</p>	8-33100190		-	-	-	-	0	-	0
 x4	<p>Fall protection steel cable kit for 4 clamps: includes 4 steel cables and mounting components. Compatible with ClampOnTyre.</p>	8-33100196		-	-	-	-	0	-	0
 x15	<p>Wheel Rim Guard Kit: Plastic protection for very protruding rims. Compatible with ClampOnTyre.</p>	8-33100197		-	-	-	-	0	-	0





OPTIONAL ACCESSORIES

Image	Description	Code		TECO 804 SPECIAL MOBILE+SMART	TECO 804 SPECIAL	TECO 814 SPECIAL	TECO 820	TECO 920	TECO 840	TECO 990
	Clamp holder multi-purpose trolley and additional jaws.	8-33100193		-	-	-	-	0	-	0
	Clamp holder set for wall mounting with support for additional jaws.	8-33100192		-	-	-	-	0	-	0
 x4	Set of 4 spacers for installation of kit 8-33100192 where ClampOnTyres are fitted with VAN extensions 8-33100191	8-33100195		-	-	-	-	0	-	-
	Steering wheel level to help in the steer position calibration procedure.	8-33100050		0	0	0	0	0	0	0
	NEXREMOTE The tablet is used as a remote control unit of the graphic user interface or as an additional portable monitor. It can also be used to show in real time to the customer the current vehicle status	8-31100001		0	0	0	0	0	0	0
	CM lift autotracking enabling kit	8-34900071		-	-	-	-	0	-	0



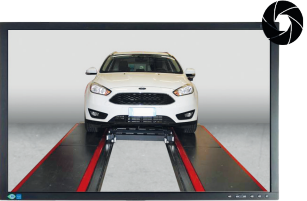


OPTIONAL ACCESSORIES

Image	Description	Code							
			TECO 804 SPECIAL MOBILE+SMART	TECO 804 SPECIAL	TECO 814 SPECIAL	TECO 820	TECO 920	TECO 840	TECO 990
	Shelf for printer Alternative mounting to the support for second LCD monitor. Mandatory if the printer is ordered.	8-34900095/90	-	-	-	-	-	-	0
	Inkjet coloured printer	8-61200237	-	-	-	-	-	-	0
	Secondary LCD display support	8-34900093	-	-	-	-	-	-	0
	Wi-Fi connection kit for INDUSTRY 4.0	8-33100174	0	0	0	0	0	0	0
	ELECTRONIC TURNTABLES CONNECTION KIT: includes 2x 16 mt connection cables for electronic turntables	8-35100076	-	-	-	-	-	0	-




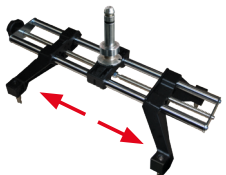

OPTIONAL ACCESSORIES

Image	Description	Code		TECO 804 SPECIAL MOBILE+SMART	TECO 804 SPECIAL	TECO 814 SPECIAL	TECO 820	TECO 920	TECO 840	TECO 990
	MNT 22 22" LCD Widescreen Monitor.	8-21100234		0	0	0	0	0	0	0
	MNT 27-M 27" LCD Multimedia Monitor.	8-34100016		0	0	0	0	0	0	0
	MNT 27 27" LCD Basic Monitor.	8-34120000		0	0	0	0	0	0	0
	MNT 32 32" LCD Monitor.	8-31600016		0	0	0	0	0	0	0

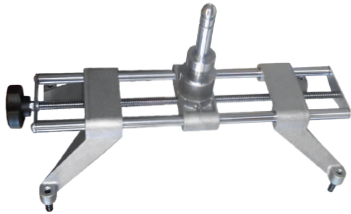


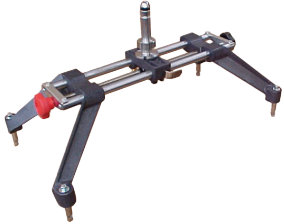
OPTIONAL ACCESSORIES

Image	Description	Code		TECO 804 SPECIAL MOBILE+SMART	TECO 804 SPECIAL	TECO 814 SPECIAL	TECO 820	TECO 920	TECO 840	TECO 990
	Universal LCD monitor holder	8-61200143		0	0	0	-	-	-	-
	Mouse kit	8-33100078		0	0	0	0	0	0	-
	Drive-On assistant: driving assistance camera for easy and correct positioning of the vehicle on the lift or in the workshop without the help of an assistant or mirrors.	8-34100032		-	-	-	-	-	-	0
	Drive on Assist kit	8-31600014		-	-	-	-	-	0	-
	Inkjet coloured printer.	8-11600135		0	0	0	0	0	0	-



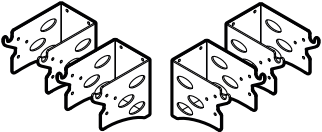


OPTIONAL ACCESSORIES

Image	Description	Code		TECO 804 SPECIAL MOBILE+SMART	TECO 804 SPECIAL	TECO 814 SPECIAL	TECO 820	TECO 920	TECO 840	TECO 990
CLAMPS										
	Quick wheel clamp 13" to 28" (for new rims or rims in good conditions); compensation kit; spacers for rounded rims included; spirit level included	8-33100146		0	0	0	-	-	-	-
	AS 4-points clamp 10"-21" with fixed central pin for cars and vans (1 pcs).	8-33100130		0	0	0	-	0	0	0
	Wheel bracket 10" to 21" for cars resin coated/double-profile claws	8-33100177		0	0	0	-	0	0	0
	AS-M Wheel bracket 10" to 21" for cars with sliding pin (1 pcs).	8-33100162		0	0	0	-	0	0	0
	Wheel bracket 10" to 21" for cars with sliding pin and resin coated/double-profile claws	8-33100176		0	0	0	-	0	0	0







OPTIONAL ACCESSORIES

Image	Description	Code		TECO 804 SPECIAL	TECO 804 SPECIAL	TECO 814 SPECIAL	TECO 820	TECO 920	TECO 840	TECO 990
				MOBILE+SMART						
	AS-2 4-points clamps 12"-21" with fixed central pin for cars and vans (2 pcs). Available extensions PC AS-2.	8-11600024		0	0	0	-	0	0	-
	AS-26 Carbon brackets 10" to 26" for cars (1 pcs).	8-33100159		0	0	0	-	0	0	0
	AM-2 Quick clamp 9" to 21" for cars (1 pcs).	8-33100025		0	0	0	-	0	0	0
	AS-25 Wheel bracket 17,5" to 25" for trucks (1 pcs) (x Teco814 Truck).	803250354		-	-	0	-	-	-	-





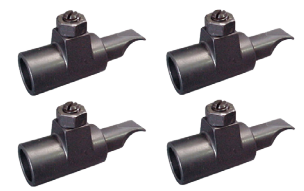
OPTIONAL ACCESSORIES

Image	Description	Code		TECO 804 SPECIAL MOBILE+SMART	TECO 804 SPECIAL	TECO 814 SPECIAL	TECO 820	TECO 920	TECO 840	TECO 990
	QCT Set of 4 skip compensation clamp for trucks (x Teco814 Truck).	8-33100051		-	-	0	-	-	-	-
CLAMP ACCESSORIES										
	SPIDER CLAMP: 4 pins for 1 clamp, suitable only on 10-26" clamp; ROC procedure is compulsory.	8-33100157		-	-	-	-	-	0	-
	K4WS 4-point clamp support brackets for on-wall installation (4 pcs).	8-31600017		0	0	0	0	-	-	-
	CAB Safety cables for measuring heads. To be fixed on clamps (4 pcs). For AS.e AS-26.	803261239		0	0	0	-	0	0	0
	PC AS-2 Extension kit for AS-2 to increase clamping till 26" (4 pcs – 2 pcs/clamps). Truck capable.	8-11600025		0	0	0	-	0	0	-




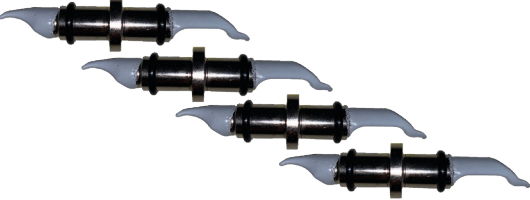
OPTIONAL ACCESSORIES

Image	Description	Code		TECO 804 SPECIAL MOBILE+SMART	TECO 804 SPECIAL	TECO 814 SPECIAL	TECO 820	TECO 920	TECO 840	TECO 990
	KIT4 AS26 Extension kit for AS-26 to increase clamping capacity of 4" (4 pcs – 4 pcs/clamp). Truck capable.	8-33100100		0	0	0	-	0	0	0
	PC AR-2 Set of three 28" extensions for single rapid clamp 8-33100025.	8-33100026		0	0	0	-	0	0	0
 x4	KIT 1-4 Grippers 43 mm for alloy rims for AS-2 (4 pcs - 4 pcs/ clamp).	100023100		0	0	0	-	0	0	0
 x4	KIT 2-4 Grippers 46 mm for thick edge rims for AS-2 (4 pcs - 4 pcs/clamp).	100023300		0	0	0	-	0	0	0
 x4	KIT 3-4 Grippers 98 mm for van rims for AS-2 (4 pcs - 4 pcs/ clamp).	100022600		0	0	0	-	0	0	0
 x4	KIT SSC-1 Double grippers for steel and alloy rims (4 pcs - 4 pcs/ clamp).	8-33100039		0	0	0	-	0	0	0





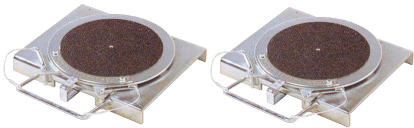


OPTIONAL ACCESSORIES

Image	Description	Code		TECO 804 SPECIAL MOBILE+SMART	TECO 804 SPECIAL	TECO 814 SPECIAL	TECO 820	TECO 920	TECO 840	TECO 990
 x4	KIT SSC-2 Double grippers for rims with wheel cover and alloy rims (4 pcs - 4 pcs/clamp).	8-33120000		0	0	0	-	0	0	0
 x4	KIT 5 Kit of short grippers for AM-2 (12 pcs - 3 pcs/clamp).	803284944		0	0	0	-	0	0	0
 x4	KIT 6 Kit of long grippers for AM-2 (12 pcs -57 mm- 3 pcs/clamp).	803284945		0	0	0	-	0	0	0
 x4	KIT 7 Kit of short shaped grippers for AM-2 (12 pcs - 3 pcs/clamp).	803284946		0	0	0	-	0	0	0
	KIT RACING Kit of 4 truck racing grippers for AS-25 (4 pcs - 4 pcs/clamp).	803258555		-	-	0	-	-	-	-


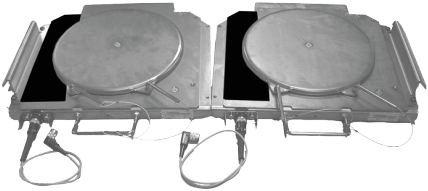

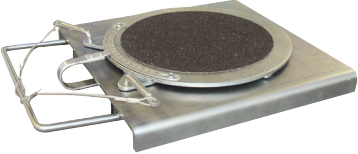
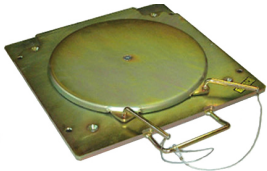
OPTIONAL ACCESSORIES

Image	Description	Code		TECO 804 SPECIAL MOBILE+SMART	TECO 804 SPECIAL	TECO 814 SPECIAL	TECO 820	TECO 920	TECO 840	TECO 990
	KIT of 4 resin coated/double-profile claws for wheel clamps code 8-33100159 and 8-33100130. One kit for one clamp.	8-33120002		0	0	0	-	0	0	0
x4 	KIT 9 Kit of short shaped grippers for AM-2 (12 pcs – 3 pcs/ clamp).	803284947		0	0	0	-	0	0	0
	Set of 6 long pins for skip compensation clamp for trucks QCT.	8-33100105		0	0	0	-	-	-	-
	Kit of 4 resin coated/double-profile SCC claws for wheel clamps code 8-33100159 and 8-33100130. One kit for one clamp.	8-33120003		0	0	0	-	0	0	0



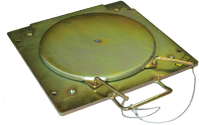



OPTIONAL ACCESSORIES

Image	Description	Code		TECO 804 SPECIAL MOBILE+SMART	TECO 804 SPECIAL	TECO 814 SPECIAL	TECO 820	TECO 920	TECO 840	TECO 990
	Set of 6 short pins for skip compensation clamp for trucks QCT.	8-33100104		0	0	0	-	-	-	-
SPOILER ADAPTERS FOR CARS, TRUKS AND BUSES										
	PS-55 Adapter for low body cars. L=55 mm.	803232814		0	0	0	-	-	-	-
	PS-90 Adapter for low body cars. L=90 mm.	803252515		0	0	0	-	-	-	-
	PS-240 Adapter for trucks and buses. L=240 mm.	803232815		-	-	0	-	-	-	-
	Pair of mechanical turntables Dimensions 375x305x50 mm - Ø 310 mm - Range ± 35 mm Load 1000 kg.	803268866		0	0	0	0	0	0	0
	Pair of pads for mechanical turntable 803268866	8-33100111		0	0	0	0	0	0	0
	High mechanical turntable for cars (wheel stop included) Dimensions 400x450x53 mm - Ø 320 mm - Range ± 40 mm. Load 1000 kg.	804241069		0	0	0	0	0	0	0






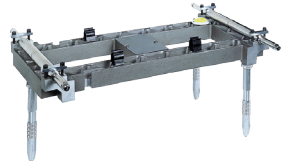
OPTIONAL ACCESSORIES

Image	Description	Code		TECO 804 SPECIAL MOBILE+SMART	TECO 804 SPECIAL	TECO 814 SPECIAL	TECO 820	TECO 920	TECO 840	TECO 990
	Medium profile turntable Dimensions 400x450x36 mm - Ø 320 mm - Range ± 40 mm Load 1000 kg	803227745		0	0	0	0	0	0	0
	ROC push-mode kit iron turntable to be combined with 804241069, 803227745 and 8-33100102. MANDATORY FOR PRODUCTS USING THE "ROC SMART" FUNCTION	803259570		0	0	0	0	0	0	0
	LPT Turntable spacers for «push-mode ROC» (2 pcs).	8-11600146		0	0	0	0	0	0	-
CAR TURNTABLES										
	CPRM-4 Pair of mechanical turntables for cars and vans. Dimensions L=350mm / H=40mm. Load 2,0T	8-21600170		0	0	0	0	0	0	0
	CPRA-2 Pair of truck turntable. Dimensions 450x450x24 mm - Ø 365 mm - Range ± 45 mm. Load 3000 kg.	100024200		0	0	0	0	0	0	0

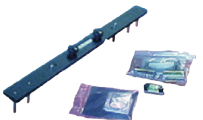


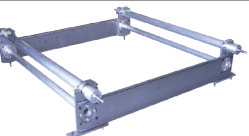


OPTIONAL ACCESSORIES

Image	Description	Code		TECO 804 SPECIAL MOBILE+SMART	TECO 804 SPECIAL	TECO 814 SPECIAL	TECO 820	TECO 920	TECO 840	TECO 990
	CPP-3 Pair of short slip plate. Dimensions 835x370x37 mm. Load 1000 kg.	8-11600184		0	0	0	0	0	0	0
	Long slip plate - 1 PIECE Dimensions 1732x535x25 mm Load 1000 kg	803231255		0	0	0	0	0	0	0
CAR TURNTABLES										
	Low profile turntable Dimensions 400x450x26 mm - Ø 320 mm - Range ± 40 mm. Load 1000 kg.	803229274		0	0	0	0	0	0	0
	Pair of truck mechanical turntables with graduated scale. Dimensions 370x458x66 mm - Ø 370 mm - Range ± 50 mm. Load 5000 kg.	8-33100099		0	0	0	-	0	0	-
	Truck turntable Dimensions 450x450x24 mm - Ø 365 mm - Range ± 45 mm. Load 3000 kg.	803230950		0	0	0	-	0	0	-
	Pair of car mechanical turntables with ROC push-mode kit (Without wheel stop). Dimensions: 485x435x48,5 mm. Load: 1000 kg.	8-34900019		-	-	-	0	0	-	-





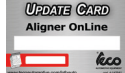

OPTIONAL ACCESSORIES

Image	Description	Code		TECO 804 SPECIAL MOBILE+SMART	TECO 804 SPECIAL	TECO 814 SPECIAL	TECO 820	TECO 920	TECO 840	TECO 990
SPECIAL ACCESSORIES FOR CARS AND VANS										
	KIT PORSCHE Porsche adaptors. Use suggested during application of «No-ROC» procedures.	3-02047		0	0	0	-	0	0	0
	KIT BM KIT BMW & Mercedes for 5 holes rims. Use suggested during application of «No-ROC» procedures.	803284942		0	0	0	-	0	0	0
	VAS BAR Specific bar for TOE measurement for VW & AUDI.	803254284		0	0	0	0	0	0	0
SPECIAL ACCESSORIES FOR TRUCKS										
	TRUCK CABLES Set of TWO 16 mt cable connection from main unit to CCD sensors for TECO 814, specially for trucks.	8-33400041		-	-	0	-	-	-	-
	KIT RIM Alignment kit for trailers and semi-trailers.	803254570		-	-	0	-	-	-	-
CALIBRATION DEVICE										
	Calibration unit provided with the full scale inclinometers calibration kit. Do not include accessories for the full scale calibration of the string aligners. For Teco 812 too.).	8-33200150		0	0	0	-	-	-	-












OPTIONAL ACCESSORIES

Image	Description	Code		TECO 804 SPECIAL MOBILE+SMART	TECO 804 SPECIAL	TECO 814 SPECIAL	TECO 820	TECO 920	TECO 840	TECO 990
	Full scale calibration kit for string aligners (to be used with 8-33200150).	8-33100199		-	-	-	-	-	-	-
	CU 820 Calibration unit. For Aftersales service.	8-34900011		-	-	-	0	0	-	0
	CU 830-840 Calibration unit composed of single bar and passive target. For After-sales service (for Teco 830 too).	8-34100010		-	-	-	-	-	0	-
CALIBRATION DEVICE										
	Reference frame for TECO 840, add one (1) unit of code 8-34100009 to obtain a complete calibration jig	8-34100005		-	-	-	-	-	0	-
	Transformation kit to convert one bar of the frame code 8-34100005 into a calibration unit code 8-34100010, or to use the frame code 8-34100005 as a calibration jig.	8-34100009		-	-	-	-	-	0	-
MISCELLANEOUS										
	Set of four emergency cables (2 cables = 7 mt + 2 cables =10 mt).	8-33100110		0	0	-	-	-	-	-

OPTIONAL ACCESSORIES

Image	Description	Code		TECO 804 SPECIAL MOBILE+SMART	TECO 804 SPECIAL	TECO 814 SPECIAL	TECO 820	TECO 920	TECO 840	TECO 990
	CBE External battery charger.	8-33100088		0	0	0	-	-	-	-
	Wireless remote control kit (with 2.4 GHz industrial radio).	8-35100060		0	0	0	0	0	0	0
	Portable induction heater.	8-35100059		0	0	0	0	0	0	0
	Trolley 2.0: to use the wheel aligner in different working bays (Delivery available both from Italy and China)	8-34900072/90		-	-	-	0	0	-	0
SOFTWARE & DATA BANK UPDATES										
	Wheel alignment On-Line databank - 10 credits card	8-33600012		0	0	0	0	0	0	-
	Data base upgrade - TECO 990	8-34100050		-	-	-	-	-	-	0
	Upgrade kit for vehicle adjustment by schematic animations	8-34900098		-	-	-	-	-	-	0
	Upgrade kit for vehicle adjustment by schematic slides	8-34900097		-	-	-	-	-	-	0
	DB USA Specific US data bank. Renewal required each years.	8-34900031		-	-	-	-	-	-	0

OPTIONAL ACCESSORIES

Image	Description	Code							
			TECO 804 SPECIAL MOBILE+SMART	TECO 804 SPECIAL	TECO 814 SPECIAL	TECO 820	TECO 920	TECO 840	TECO 990
	PGR T804 Operative graphic guidance program (for Teco 804 old version, not Special)	8-33300006	-	-	-	-	-	-	-
	PGR T804 Operative graphic guidance program.	8-33300045	0	0	0	-	-	0	-
	DB T804 Data bank update. (for Teco 804 old version, not Special)	8-33100134	-	-	-	-	-	-	-
	DB T810-812 Data bank update for TECO 810-812.	8-33600002	-	-	-	-	-	-	-
	DB T814 Data bank update (for Teco 814 old version, not Special).	8-33100156	-	-	-	-	-	-	-
	DB T840 Data bank update.	8-33100128	-	-	-	-	-	0	-
	DB USA Specific US data bank. Renewal required each years.	8-33100125	0	0	0	-	-	0	-
	DB T804 Special Mobile, T804 Special, T814 Special Data bank update	8-33200065	0	0	0	-	-	-	-
	KIT TRUCK TECO 814 Alignment software for trucks, trailers and buses (for Teco814 old version only , not Special).	8-33600008	-	-	-	-	-	-	-
	KIT TRUCK TECO 814 SPECIAL Alignment software for trucks, trailers and buses (for Teco814 SPECIAL only).	8-33600010	-	-	0	-	-	-	-
	AVP kit (Audi, VW procedure)	8-34100027	-	-	-	-	0	-	-
	AVP kit (Audi, VW procedure)	8-33300042	0	0	0	-	-	0	-



AUTOMOTIVE EQUIPMENT



NEXION SPA - ITALY -
AUTOMOTIVE EQUIPMENT www.tecoautomotive.com - teco@teco.it

Sede operativa: Via Dinazzano, n. 4 - 42015 Prato di Correggio (RE) ITALY - Tel.: +39 0522 631562 - Fax +39 0522 642373

Cod. DPTC000189_WA_EX_03_2024